

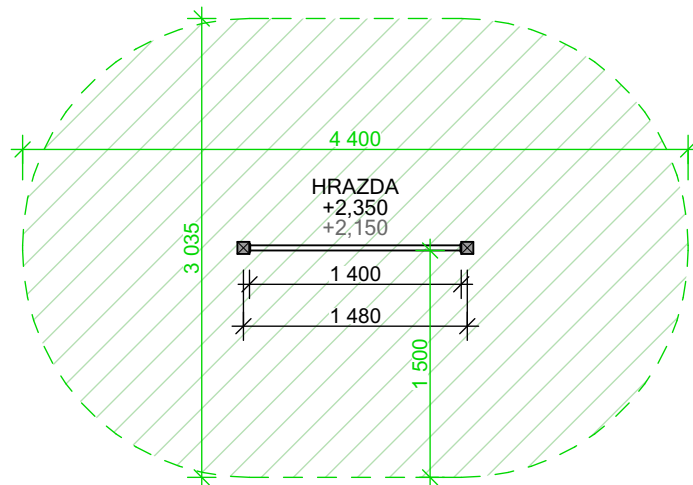



# PŮDORYS



# LEGENDA

-  JÄKL 80/80/3
-  OCELOVÉ TRUBKY
-  DOPORUČENÁ DOPADOVÁ PLOCHA PRO KRITICKOU VÝŠKU PÁDU <1,5m DLE NORMY ČSN EN 1176
-  BETON C20/25

Velikost dopadové plochy:

**11,40 m<sup>2</sup>**

# PŮDORYS ZÁKLADŮ

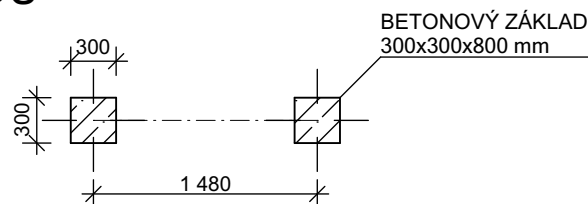

# ŘEZ ZÁKLADY

KOTVENÍ NA BETONOVÉ PATKY

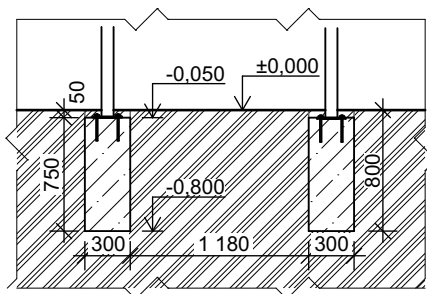

KOTVENÍ ZALITÍM

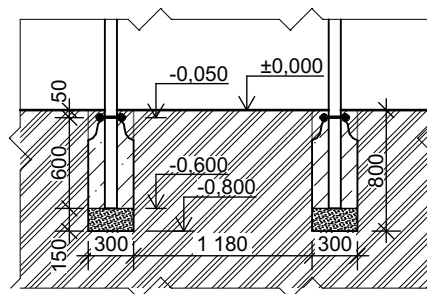

# VIZUALIZACE



your workout brand <b>W O club</b> <sup>®</sup>		
PROJEKTOVAL	Bc. Tomáš Maxner	
KRESLIL	Bc. Tomáš Maxner	
SINGLE BAR TOP	DATUM	2020
	MĚŘÍTKO	1:50
TECHNICKÝ VÝKRES	FORMÁT	1xA4
	Č.V.	1