

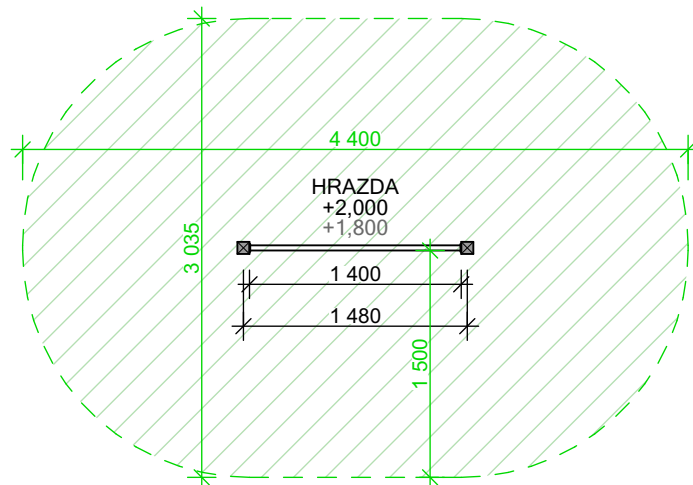



PŮDORYS



LEGENDA

-  JÄKL 80/80/3
-  OCELOVÉ TRUBKY
-  DOPORUČENÁ DOPADOVÁ PLOCHA PRO KRITICKOU VÝŠKU PÁDU <1,5m DLE NORMY ČSN EN 1176
-  BETON C20/25

Velikost dopadové plochy:

11,40 m²

PŮDORYS ZÁKLADŮ

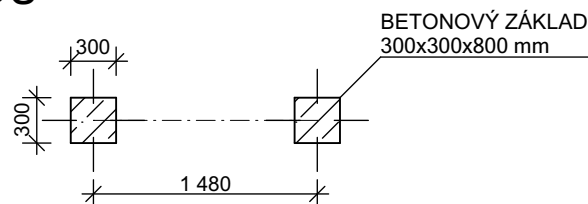

ŘEZ ZÁKLADY

KOTVENÍ NA BETONOVÉ PATKY

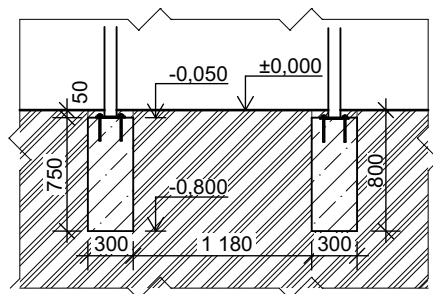

KOTVENÍ ZALITÍM

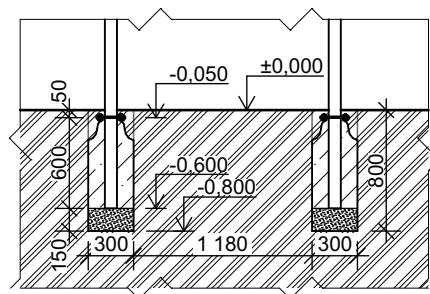

VIZUALIZACE



your workout brand W O club [®]		
PROJEKTOVAL	Bc. Tomáš Maxner	
KRESLIL	Bc. Tomáš Maxner	
SINGLE BAR HI	DATUM	2020
	MĚŘÍTKO	1:50
TECHNICKÝ VÝKRES	FORMÁT	1xA4
	Č.V.	1